

Numerical simulation sequence in applying to facility for sports and entertainment skiing slopes

M. Samofalov

Vilnius Gediminas Technical University, Saulėtekio 11, 10223 Vilnius, Lithuania, E-mail: Michail.Samofalov@vgtu.lt

1. Introduction

The sports and entertainment untypical buildings designed for 1000 (or more) visitors are of special interest among structures of civil engineering. In addition to their direct application such social centres emphasize the prestige of their founders. In this case the aim of the architects and engineers is selection of the most efficient decisions with due to account of operational, structural, technological and other characteristics of a specific building to be designed in order to demonstrate its unique application [1-3]. Accordingly, development of design parts and choice of realization manner of such kind of solutions are being prepared individually on the basis of the theoretical methods [4] and professional skills of designers' team [5]. In contrast to serial structural solutions for sports and entertainment buildings, the requirements for the original ones have the most common way, because their task is to provide some minimal demands [6-12]. The design codes do not answer the question about the most reasonable and proper methods of the decision (according to the actual mechanical state of constructions in operating, mounting etc. periods) appearing during development of a design.

It should be noted, that the engineering approaches presented in the design codes concerning estimation of the mechanical state of a construction (nonlinearity including) are considered as preliminary with individual investigation of the complex engineering system. In solving the problem of availability and allowance for nonlinearities the degree of the structural safety (reliability) is of great importance [11, 12]. The practical designing experience shows that structural designs of the important complex should be developed using an individual scheme [1, 3, 5], which takes into account a stage-by-stage character of the investigations and skills of performing both numerical calculations [13, 14] and research of real structural defects and/or laboratory experiments [2, 15, 16].

Numerical analysis of difficult mechanical systems by applying only one stage (classical solution) does not indicate the real stress/strain state and can give the erroneous results [4]. The negative feature is the fact that during single-stage calculation the alternative solutions cannot be compared. While comparing the results it is possible, besides making a general analysis, to exclude insignificant factors and to emphasize the urgent ones – thus providing improvement of the design quality.

2. Single-stage and stage-by-stage calculations

A conventional model, applied in the classical mechanics [17, 18], considers over-ground bearing structures during design of which in addition to the stress/strain state parameters one obtains the force reactions in the sup-

port points (eliminated *degrees of freedom* (DOF) in *finite element method* (FEM) models). Further, by loads from over-ground structures (or by force reactions in the support points) one can calculate the under-ground structures (foundation plate, piles, grills, etc.) of the building and to check conditions of strength and settlement of the foundation (Fig. 1). Such an approach is suitable for buildings of regular structural grid, small in plane and for a not high facility on a slightly deformable ground. A problem according to the conventional model can be solved by applying a linear or nonlinear analysis [19].

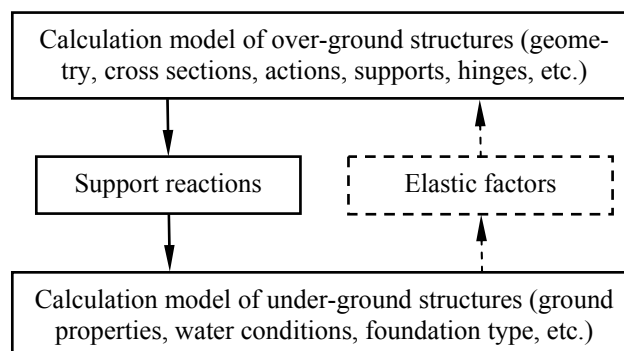

Fig. 1 Conventional model of the single-stage calculation in a simple structural design

While designing facility of considerable dimensions in plane (or very high buildings, or buildings on a highly deformable ground) it is evident that to perform analysis of the stress/strain state not sufficient using a single-stage model as an assumption about simultaneity of actions and a response reaction produces essential disagreement in comparison with the equilibrium mechanical state of the real building. Such a kind of constructions should be researched stage-by-stage providing for analysis of the intermediate data about structural features and improvement of the decision. Conclusions about structural state and efficiency of variations should be made on the basis of comparing results obtained in the various models with different assumptions.

In terms of experience in civil engineering designs of real buildings and investigations of the possibilities in stage-by-stage structural calculations the following designing scheme is suggested (Fig. 2).

1. *Calculation of separate principal structural parts of facility.* For the framework facility such parts can be transversal frames, for a high building – separate storeys or even separate slabs and columns, for axisymmetric construction (e. g., a cylindrical tank) – segments with appropriate boundary conditions. This is a simplified calculation which aims are: to choose cross-

sections of the structural members, to predict types of joints, to select preliminary characteristics of materials etc. At the given stage in addition to the over-ground construction one should check under-ground part of facility and also individual structural members connecting the main structural parts (for example, in case of transversal frames – under-crane beams, braces, etc.).

As to the usage of calculation resource (time of calculation, time for the analysis of results, time to complete a technical report of engineering calculations, etc.) the preliminary stage does not require considerable expenses but the experience of the design engineers must be essential. By the way, the skills of such a specialist in software application may be minimal.

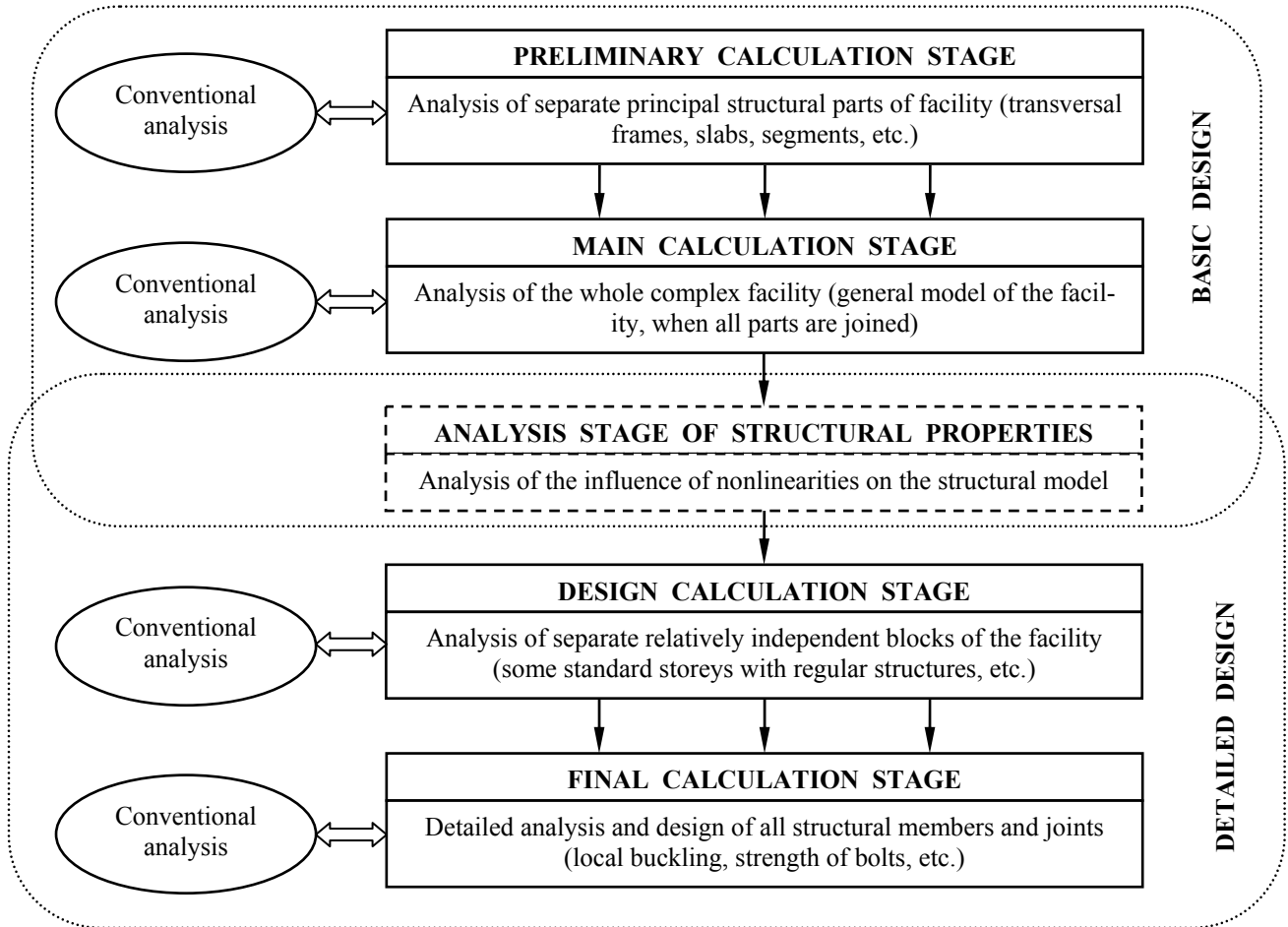

Fig. 2 Diagram of stage-by-stage design of the complex facility

2. *Design of the whole complex facility*, if it is not divided into absolutely separate parts. The purpose – to solve the problem of the influence on stress/strain state of principal calculation parts in case of a general jointed model. A general calculation model of the whole facility can be rather bulky and inconvenient as far as the used computer resources are concerned. To the point, real capabilities of hardware and software can dictate accuracy of the calculation model but not its dimensions (building gabarits). Nevertheless, general calculation model is important due to a possibility to find out potentially dangerous zones on the whole construction. It should be noted, that this calculation stage must not be the last in the considered sequence and the given results (not being investigated in details) cannot be directly used for the final drawings of the building design. Simulation of the above-mentioned general calculation model of the whole complex facility requires a high level of knowledge of the software engineer.
3. *Analysis of the influence of nonlinearities on the build-*

ing structural model. Geometrical, physical and technological nonlinearities inevitably affect on all constructions but for complex facility this influence is considerable and thus cannot be ignored. In the presented paper the nonlinearities mean:

- physical, i. e., nonlinear deformation of a material under an external load;
- geometrical, i. e., nonlinear variation of the structure deformed shape under an external load;
- technological for structural materials, i. e., manifestation of different properties of the concrete resistance (strength, flexibility, instability) and ground foundation under long- or short-term actions as well;
- technological for the facility as a mechanical system, i. e., fundamental change of the construction depending of the parameters of the stress/strain state or/and variation of the static and kinematic boundary conditions.

The question of appearance of the nonlinear structural

properties for the complex system is especially individual, here the key role plays observation of constructions, which are being built. For computer resources the stage of nonlinear design is the most laborious. In contrast to nonlinearities of the materials, structural nonlinearities can be excluded by the principal solutions taken by the engineer (exclusion of the usage of flexible braces, replacement of natural soft ground by the filled up one with more appropriate properties and so on). Such decisions simplify the building technology and operational monitoring, but they are not always well-founded from the economic point of view.

4. *Analysis of separate relatively independent blocks of the facility.* They can be individual deformational blocks of a large in plane construction or sections of tower building (for example, several storeys under building roof, some standard storeys with regular structures, some storeys of the lower part with foundation). At the given stage one selects all designed parameters (reinforcing of concrete, cross-sections of steel structures, arrangement of piles etc.) and unification of the decisions takes place. As to calculation resources, this stage is rather complicated because the analysis is performed with allowance for nonlinearities to be considered. By the same token, modern design methods of reinforced concrete and steel structures are based on the iteration procedures [6 - 8].
5. *Refinement of urgent fragments.* Mainly, this is the calculation of structural joints (local buckling, strength of bolts, etc.) and individual strengthening of structural members. As a rule, variation of cross-sectional rigidity to 25% does not produce essential influence on distribution of internal forces in static indeterminacy systems, in static determinacy it does not depend on the internal forces at all. Therefore, in case of iteration refinement of the cross-section, recalculation of internal forces of the whole system is often not reasonable.

The first three stages of the calculations are carried out at the basic design. In this case nonlinearities to be taken into account are considered with reference to the model of the whole building and it cannot be thoroughly analyzed due to limited technical capabilities of the hardware, expenses of the calculation time and incompleteness of architectural and engineering decisions (contractors are unknown, exact parameters of technical equipment are unknown, etc.). Therefore, the final nonlinear analysis is made in detailed design.

The steps of the conventional linear calculations “over-ground construction/support reactions/under-ground construction” are repeated with different degree of accuracy at each step of the stage-by-stage calculation.

3. Practical realization

The above-described sequence has been really applied to the facility [20] “Skiing slopes with snow pavement in Druskininkai, Lithuania” (Fig. 3).

According to its functional application the facility is divided into three main zones (Fig. 4): an indoor skiing slope of 422 m length (202 m of which pass over ground, the rest – over the slab); an outdoor skiing slope of 512 m length (338 m over ground, the rest over the slab); children skiing slope of 2000 m² area. The most deepened over-ground part of the structure is located at the altitude of

–29.0 m, the highest one – at altitude +51.0 m. Dimensions of the complex facility in plane are 422×200 m. The construction is divided into 8 main temperature-deformational blocks (Table). During use of the facility the temperature in indoor and children skiing slopes should be kept at a level of –5°C the whole year round. Service life of the facility is 100 years, a class of responsibility RC3 [11, 12].

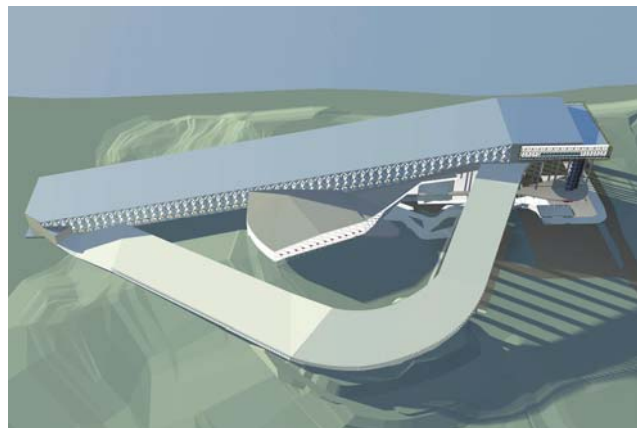

Fig. 3 A general view of the skiing slope facility in Druskininkai, Lithuania

The facility is of framework type, the main step of transversal frames is 12 m. At levels of the roof and skiing slope a bay between the frames is overlapped by truss-type purlin. In blocks “D” and “E” the columns are made of reinforced concrete, in the rest – steel ones. The bay of the steel trusses of the indoor skiing slope is 50 m, trusses and columns are rigidly joined, and connections between the columns and foundations are rigid as well. The foundations are pile-supported. The general rigidity and stability of the whole building is provided by a system of flexible pretension braces. For the columns and foundations the concrete class C30/37 is adopted in the calculations, for the trusses and purlin – the steel class S355. The respective mechanical characteristics of the materials are accepted according to the current codes [7-10].

Table
Dimensions of deformational blocks

Sign	Sizes in plane, m	Height, m	Slope
A	52×60	51	indoor
B	52×48	51	indoor
C	52×120	42	indoor
D	52×96	20	indoor
E	65×98	20	indoor
F ₁	28×114	37	outdoor
F ₂	36×60	16	outdoor
G	60×92	19	children

Climatic exposures to the facility correspond to the code requirements [21, 22], temperature actions have been considered because of division in temperature blocks. The technological affects from the special equipment are rather considerable only in local zones, they are pointed out in the design requirements of the engineering networks. Factors of safety on actions and materials as well as the ratios of loading combinations are taken according to the valid codes [7–10, 21, 22].

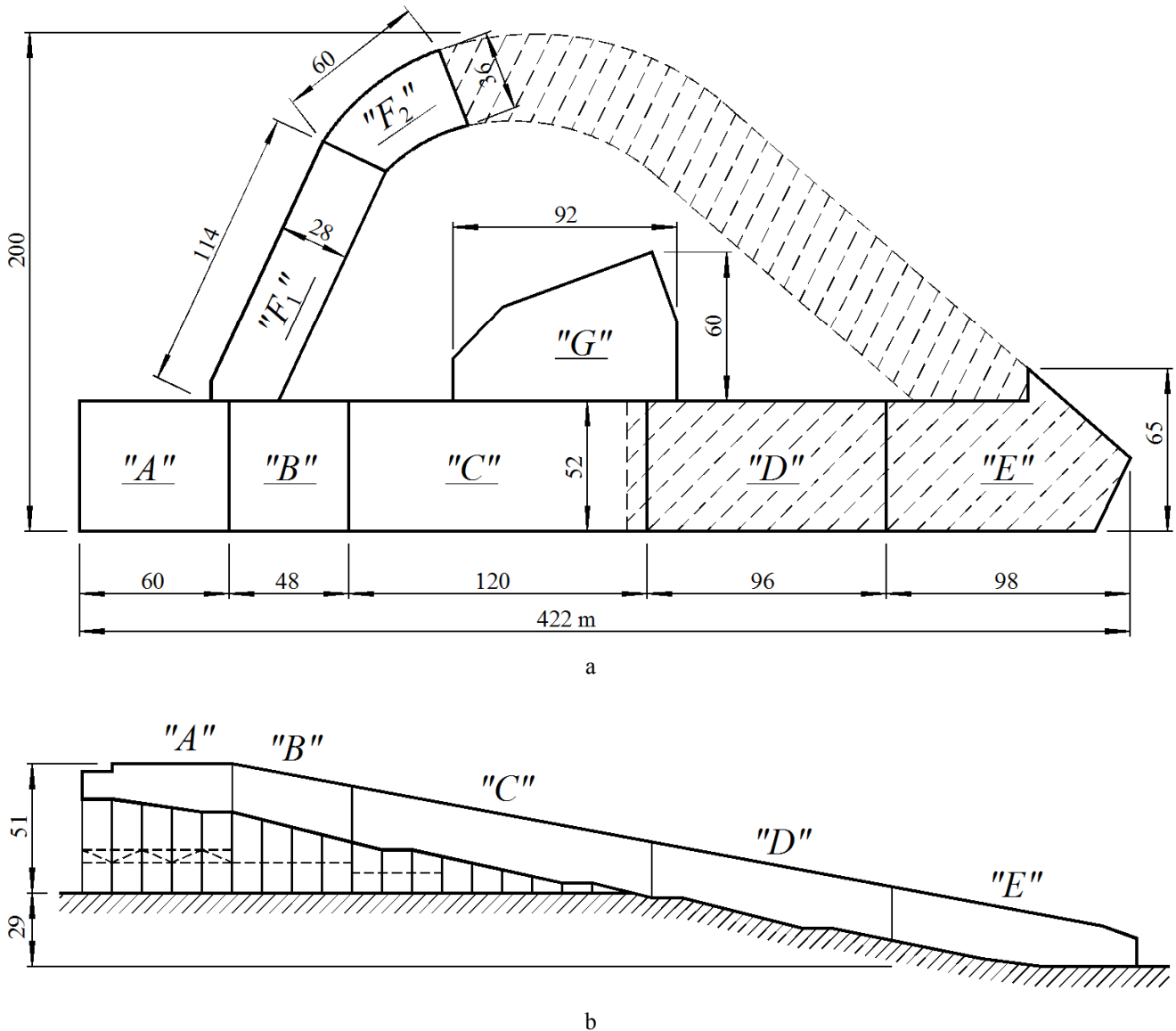

Fig. 4 Separation of the complex structures by applications: plane (a); side view (b)

Key factors in creation of the rational algorithm for the investigation of complex mechanical system are features of an individual real situation. In case of the skiing slope complex it is a high degree of regularity and repetition of the construction in the longitudinal direction and also division into rather independent blocks according to functional-operational and temperature-structural signs. As important features one should also mention usage of the pretension braces, mounting of which requires exceptional attention but in return it must provide general cost saving for the materials.

At the first (preliminary) stage of calculations some typical transversal frames (Fig. 5) with appropriate actions and out-of-plane braces have been selected from each temperature-deformation block and individually considered. Designing of the reinforced concrete members has been performed with allowance for permissible percentage of reinforcing, steel members – by a bearing capacity. Cross-sections of the braces have been selected according to design requirements to flexibility, of purlin – by calculations of separate structural members.

At the second (global simulation) stage the calculation model of the whole facility has been simulated in order to estimate the influence of spatial conditions of the structures on the stress/strain state of the transversal frames. Important attention has been paid to the zones of deformational seams between the blocks, in which the purlin rested on movable with their one edge. A very interesting question at this stage is selection of appropriate values of pretension forces for the flexible braces. The fact is that a flexible brace is efficient if tension forces are acting only. In case of compression such structural member should be “removed” from the system on the current iteration step. This is especially difficult for the system of a large number of the DOF, because in case of “disconnection” of even one brace the whole system should be recalculated and a new distribution of internal forces can appear. Also the calculation time is effected by a number of load combinations to be considered. On the other hand, the number of load combinations should be sufficient because all real situations should be analyzed – this condition is very important for a nonlinear calculation, the time of

which must be clearly described. Eventually, all braces must be included into operation with least possible pretension.

Bearing in mind, that each deformation block of the facility is sufficiently regular in plane and the transversal frames are jointed by independent additional structural members, i. e., purlin bear the profiled sheeting, it is quite reasonable for the distribution of internal forces to use pretension braces. In the whole facility calculation the initial cross-sections of the flexible braces are selected by the tensile condition. Both an initial pretension force (as a static factor) and preliminary handpicked area of the cross-section (as a kinematic factor) depend on the distribution of internal forces in operational period. Both of these parameters are again partially affected by themselves in statically indeterminacy system. It makes the essence of the iteration process, in which the stress state of the “closed” system is tightly related with the strain state. Selection of the braces is carried out by three main steps:

- 1) preliminary cross-sectional areas and pretensional forces are predetermined;
- 2) flexible braces are grouped, cross-sectional areas and pretensional forces are iteratively reset, with account for actual stress/strain state;
- 3) final calculation of the whole facility with the last parameters of the braces is accomplished.

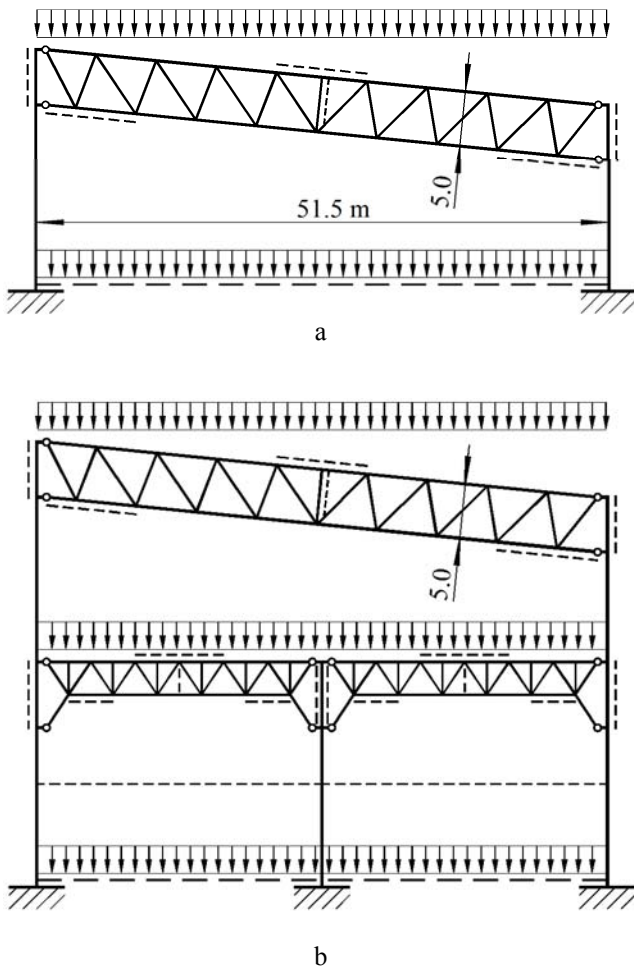

Fig. 5 Principal transversal frames from respective regular sectors: from block “E” (a); from block “B” (b)

At the second stage, optimization of design parameters is mathematically expressed by convergence of a general function. It should be noted, that a criterion of application and selection of flexible braces is not only their strength but stability of the whole construction at shear and torsion and also flexibility in the horizontal direction. For a huge numerical model an exact analysis of the pretension flexible braces can be very complicated, so such kind of the solution procedure should be done rather roughly taking generalizing assumptions.

At the stage of the analysis of individual deformation blocks (Fig. 6 and 7) the above-specified selection of the braces is performed and also designing of all structural members should be checked. In this case, calculation of the braces should be brought to the end and thus it is made exactly enough (Fig. 8 and 9). Also cross-sections of all structural members are defined rather exactly. At the given stage calculation of the joints does not take place.

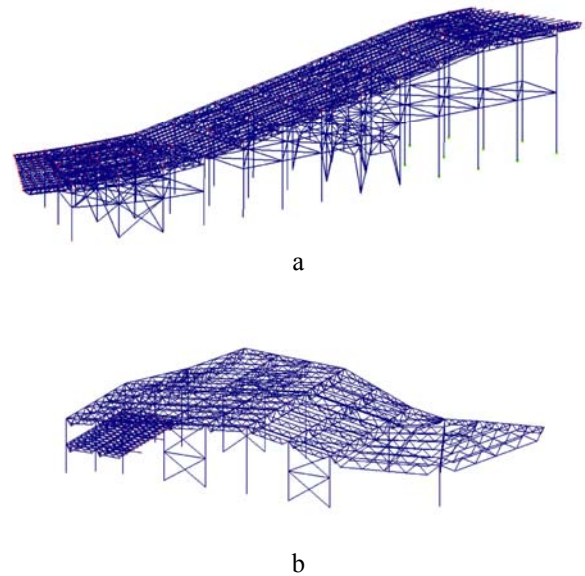

Fig. 6 Calculation models of: outdoor (a) and children (b) skiing slopes

At the final stage, the joints are calculated and decisions are unified. Cross-sections of some structural members can be replaced (from joint designing conditions). The data for the detailed design documentation is being prepared.

4. Generalization of the research concepts

The suggested sequence to manage structural calculations is not the only one and it can be developed depending on the construction features, skills of the engineering staff in a building site region, experience of the designers’ team, software or hardware possibilities, etc. Nevertheless, for advanced calculation models it is quite necessary to plan the simulation stages and respective resources. For this, one can employ enormous experience accumulated in planning of natural experiments with buildings and laboratory ones with scale-models [15, 16]. Usage of theoretical knowledge of classical theories [17–19, 23–25] and skills of optimization [26–29] are also of great importance.

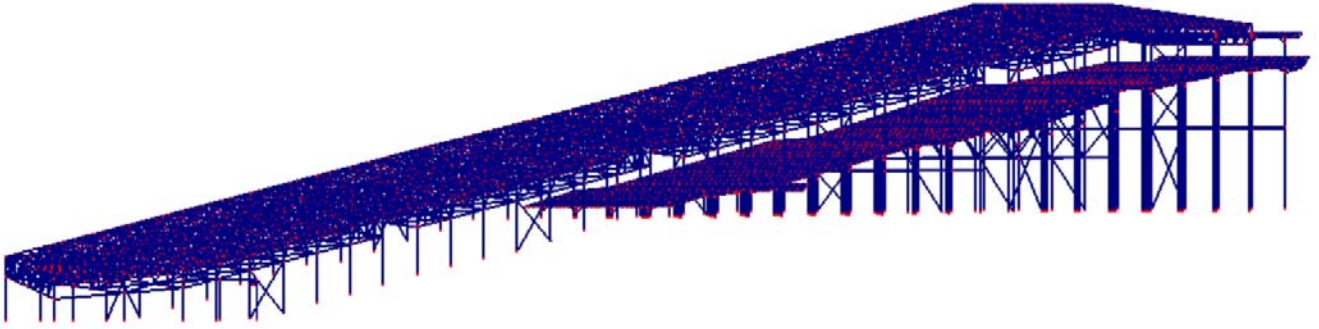

Fig. 7 Calculation model of the indoor skiing slope

In the above-presented example it was reasonable to consider only one type of nonlinearities – technological for the construction as a system – according to the above-mentioned classification. Other types of nonlinearities (unequal response of the materials to long and short-term exposures, plastic deformation of the materials and so on) are not dangerous for this facility to be considered. Nevertheless, if there are several types of nonlinearities in one calculation model then while planning efficient sequence of the design the necessity can arise for parallel investigation of individual nonlinear processes. In any case, the problem of order of different load acting and consideration of load combinations, which can be very complicated for real complex facility design, remains open and it is decided only at the level of engineering hypotheses as in our case. Usage of classical (physical, geometrical) or technological nonlinear decisions more exactly reflects the structural features of the real operation facility in a calculation model.

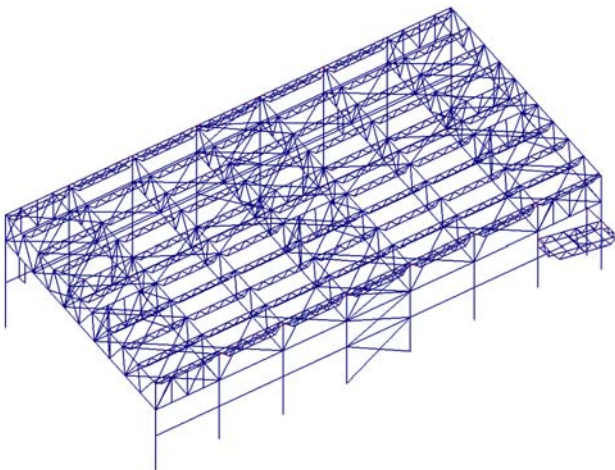
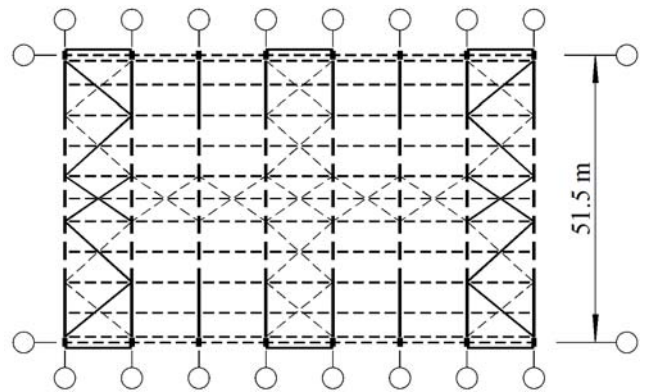

Fig. 8 Calculation model of deformation block “D”

In the presented paper only long-term operation period of the facility is described. Other service life periods (mounting, repair, current replace of snow-cover, etc.), which can be also very important in the calculation of the bearing structures (or groups or separate structural members, joints) are not considered. For example, for the presented facility in each of deformation block the pretension forces of the flexible braces have simultaneously and uni-

formly increased in proportion to the design values – this is very complicated requirement from the practical point of view of such technological process. The choice of the pretension sequence during mounting for the complex system of the braces, as in our case, is a separate problem of optimization [30, 31].



a

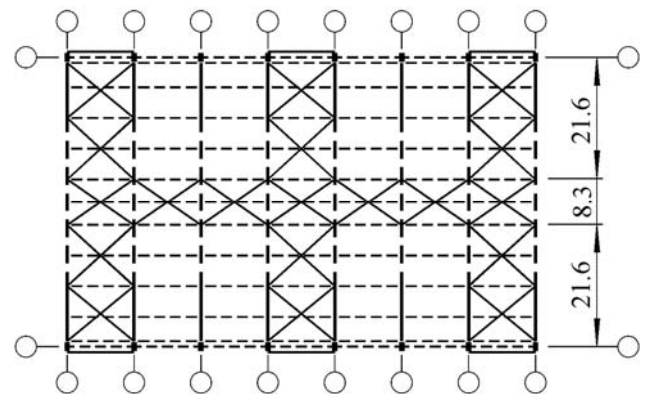

b

Fig. 9 An example of stage-by-stage selection of pretension forces and cross-sections of the system of flexible braces (pretension force and diameter) for block “D” (compression is drawn by hidden line): 100 kN and 25 mm (a); 125 kN and 30 mm (b)

5. Conclusions and recommendations

On the basis of the results of above-presented investigation the following conclusions and recommendations have been briefly drawn:

1. Usage of advanced software and modern hardware enables to solve rather complex problems of a huge number of DOF. Solution of such problems by only one stage (and given results), frequently does not exactly display the real stress/strain state of the complex facility. Therefore, an exact analysis should be performed by stages, considering different models in principle. It is also very important to understand and to take into account the purpose of creating a calculation model (for example, to obtain internal forces in the columns it is not quite necessary to consider the finite element grid of slabs in details).

2. For large in plane or tower-type models calculations of stress/strain state parameters should be done according to the pre-developed sequence of investigations, considering a degree of structural reliability. For real complex facility if one desires to get high-quality results, it is practically impossible to avoid a nonlinear analysis. When designing complex problems one needs the skilled support of scientific organizations and design institutions, having an appreciable experience in structural calculations of non-standard facilities.

3. Application of advanced software does not at all exclude the analysis of alternative design models. On contrary, it is necessary to improve management in designing providing for the calculation of alternative models in different design institutions by different engineers and/or employing different software.

Acknowledgement

The author expresses his thanks to the municipality administration of Druskininkai and general design management company "Urban.lt" for the given opportunity to familiarize engineers of Lithuania and other countries with scientific principles of the basic design (April 2009) of the skiing slope facility.

References

1. **Samofalov, M., Cvirka, V.** Mechanical state analysis and an original sequence of calculations of a huge bay arch under static and dynamic actions.-Proc. 10th Int. Conf. MBMST2010. -Vilnius: Technika, 2010, v.2, p.1054-1054.
2. **Samofalov, M., Pavlovsky, R., Popov, V., Lebedich, I.** Experimental aerodynamic investigation of shape properties of National stadium in Vilnius.-Proc. 13th Int. Conf. Mechanika-2008. -Kaunas: Technologija, 2008, p.456-461.
3. **Samofalov, M., Popov, V., Kriksunov, E., Perelmutter, A.** Numerical modelling of a long storage facility foundation plate under seismic actions.-Proc. 9th Int. Conf. MBMST2007. -Vilnius: Technika, 2007, v.3, p.763-772.
4. **Samofalov, M., Papinigis, V.** Quality problems of Lithuanian civil engineering design documentation.-Proc. 10th Int. Conf. MBMST2010. -Vilnius: Technika, 2010, v.2, p.768-777.
5. **Samofalov, M., Šlivinskas, T.** Stability analysis of steel frames with variable cross-section for sports and entertainment centre. -Mechanika. -Kaunas: Technologija, 2009, v.79, No. 5, p. 5-12.
6. SP 52-101-2003. Concrete and Reinforced Concrete Structures without Pre-stressing.-Moscow, 2004.-36p. (in Russian)
7. Eurocode 2. Design of Concrete Structures. Brussels: CEN.
8. Eurocode 3. Design of Steel Structures. Brussels: CEN.
9. STR 2.05.08. Design of Steel Structures. Vilnius. (in Lithuanian).
10. STR 2.05.05. Design of Concrete Structures. Vilnius. (in Lithuanian).
11. STR 2.05.03. Basis of Structural Design. Vilnius. (in Lithuanian).
12. Eurocode 0: Basis of Structural Design. Brussels: CEN.
13. **Perelmutter, A., Fialko, S.** Problems of computational mechanics relate to finite-element analysis of structural constructions. -International Journal for Computational Civil and Structural Engineering, 2005, v.1, No.2, p.72-86.
14. **Perelmutter, A., Slivker, V.** Calculation Models of Buildings and Possibility for their Analysis. 3rd ed. -Moscow: DMK Press, 2007.-595p. (in Russian)
15. **Wu, C., Hamada, M.** Experiments: Planning, Analysis, and Parameter Design Optimization. -USA: John Wiley & Sons, 2000.-625p.
16. **Kasatkin, B., Kudrin, A., Lobanov, L., Pivtorak, V., Poluchin, P., Chichenev, N.** Experimental Research Methods of Stress and Strain. Reference Manual.-Kiev: Naukova Dumka, 1981.-584 p. (in Russian).
17. **Fesik, S.** Handbook of Strength of Materials. 2nd ed. -Kiev: Budivelnik, 1982.-280 p. (in Russian).
18. **Klepikov, S.** Calculation of Facilities on Deformable Foundation. -Kiev: NIISK, 1996. -204p. (in Russian).
19. **Smirnov, A., Aleksandrov, A., Laschenkov, B., Shaposhnikov, N.** Structural Mechanics. Dynamics and Stability of Buildings. -Moscow: Strojizdat, 1984. -415p. (in Russian).
20. Skiing Slops with Snow Pavement in Druskininkai, Lithuania. Architectural Chapter. Basic Design.-Vilnius: Urban.lt, April 2009.-79p. (in Lithuanian)
21. Eurocode 1: Actions on Structures. Brussels: CEN.
22. STR 2.05.04. Actions and Loads. Vilnius. (in Lithuanian).
23. **Slivker, V.** Structural Mechanics. Variational Principles. -Moscow: ASV, 2005.-736p. (in Russian)
24. **Perelmutter, A., Slivker, V.** Equilibrium Structural Stability and Related Problems. -Moscow: SCAD Soft, 2010, v.1, v.2. -704p., 672p. (in Russian).
25. **Johnston, B., et al.** Guide to Stability Design Criteria for Metal Structures. 3rd ed. ISBN 0-471-44629-7. -USA: John Wiley & Sons, 1976.-616p.
26. **Permiakov, V., Perelmutter, A., Jurchenko V.** Optimal Design of Steel Structures. -Kiev: SCAD Soft, 2008. -538p. (in Russian).
27. **Jankovski, V., Atkočiūnas, J.** MATLAB implementation in direct probability design of optimal steel trusses. ISSN 1392-1207. -Mechanika. -Kaunas: Technologija, 2008, v.74, No. 6, p. 30-37.
28. **Kalanta, S., Atkočiūnas, J., Venskus, A.** Discrete optimization problems of the steel structures. -Engineering Structures. -Elsevier, 2009, v.31, No.6, p.1298-1304.

29. **Atkočiūnas, J., Merkevičiūtė, D., Venskus, A.** Optimal shakedown design of bar systems: strength, stiffness and stability constraints. -Computers & Structures. -Oxford: Pergamon, 2008, v.86, iss.17-18, p.1757-1768.
30. **Kornilov, V.** Programming of Optimal Sequence of Pre-stressed Structural Guy Ropes. -Moscow: Strojizdat, 1978. -100 p. (in Russian).
31. **Žiliukas, A.** Plate buckling under complex loading. -Mechanika. -Kaunas: Technologija, 2008, v.74, No. 6, p. 17-20.

M. Samofalov

SLIDINĖJIMO TRASŲ SPORTO IR PRAMOGŲ STATINIO SKAITINIO MODELIAVIMO NUOSEKLUMAS

R e z i u m ė

Straipsnyje siūloma nuosekliai planuoti sudėtingų inžinerinių statinių projektų skaičiavimus. Nagrinėjama galimybė konstrukcijų įtempimų ir deformacijų būvį tirti etapais, atsižvelgiant į netiesiškumo požymius. Išvadas apie sistemos mechaninį būvį siūloma grįsti alternatyvių skaičiuojamųjų modelių analizės rezultatų gretinimu. Sudėtingo statinio veiksmingo skaičiavimo nuoseklumui ypač didelę reikšmę turi jo originalios savybės ir realios situacijos ypatumai. Rengiant statinio projekto inžinerinę dokumentaciją, kiekviename skaičiavimų etape ypač svarbūs yra kompiuterio išteklių bei inžinierių kvalifikacijos klausimai. Anksčiau aptarta skaičiavimų tvarka 2009 m. praktiškai pritaikyta Druskininkų slidinėjimo trasai su dirbtine sniego danga projektuoti. Šio statybos komplekso laikinųjų konstrukcijų ypatingos savybės – reguliariai besikartojantys rėmai bei skaidomumas į nepriklausomas dalis. Šiuo atveju sėkmingai panaudota iš anksto įtemptų ryšių sistema leidžia taupyti medžiagas, tačiau verčia spręsti netiesinį uždavinį. Sudėtingo statinio konstrukcijų būvio kokybiškai ištirti faktiškai neįmanoma be iš anksto kruopščiai parengtos tyrimų programos.

M. Samofalov

NUMERICAL SIMULATION SEQUENCE IN APPLYING TO FACILITY FOR SPORTS AND ENTERTAINMENT SKIING SLOPES

S u m m a r y

In this paper a sequence to manage engineering calculations in design of complex facilities is proposed. A possibility of stage-by-stage sequential analysis of the structural stress/strain state is considered taking into account nonlinear aspects. The conclusions are recommended about the system mechanical work based on comparison of analysis of final results from alternative calculation models. Original features of a complex facility and real design

situation particularities play a key role in creation of an effective calculation sequence for the facility. The structural calculations are tightly connected with preparing of design documentation for the facility, so questions about computer resources and qualification of engineers can be very important on each calculation stage. The above-proposed sequence has been practically used to the basic design of the facility “Skiing slopes with snow pavement in Druskininkai, Lithuania” in 2009. In this case, the structural features are: high level of regularity; a possibility to divide the facility constructions in structurally independent blocks. A system of flexible pretensioned braces has been successfully applied. Usage of such a kind of structural members allows to consider such calculation as nonlinear one. Preliminary planning of structural stress/strain state investigations is obligatory for the calculations of complex facilities.

М. Самофалов

ПОСЛЕДОВАТЕЛЬНОСТЬ ЧИСЛЕННОГО МОДЕЛИРОВАНИЯ ПРИМЕНИТЕЛЬНО К СПОРТИВНО-РАЗВЛЕКАТЕЛЬНОМУ СООРУЖЕНИЮ ЛЫЖНЫХ ТРАСС

Р е з ю м е

В статье предлагается систематизировать расчётную часть проектов сложных сооружений. Рассматривается возможность поэтапного исследования напряжённо-деформируемого состояния конструкций, учитывая в расчётах нелинейные эффекты. Выводы о механической работе системы рекомендуется обосновать сравнением результатов анализа альтернативных расчётных моделей. Ключевую роль в создании эффективной последовательности выполнения расчётов любого сложного сооружения играют его оригинальные свойства и особенности реально сложившейся ситуации. Проведение расчётов тесно связано со стадиями разработки инженерной проектной документации сооружения, при этом важны вопросы компьютерных ресурсов и квалификации инженеров на каждом этапе расчёта. Оговорённая последовательность проведения расчётов реализована при проектировании строительного объекта «Лыжные трассы с искусственным снежным покрытием в г. Друскининкай, Литва» в 2009 г. Особенности несущих конструкций этого комплекса – высокая степень регулярности, а также возможность разделения на самодостаточные по конструктивным признакам блоки. В данном случае удачно применена система гибких связей с предварительным натяжением, что позволяет экономить материалы, но делает расчёт нелинейным. Предварительное планирование исследования состояния конструкции фактически неизбежно в расчётах сложных сооружений.

Received July 24, 2010

Accepted December 07, 2010