



NUMERICAL SIMULATION STRATEGY OF REINFORCED CONCRETE TUNNEL BEARING MEMBERS IN FIRE

Viktor Gribniak, Darius Bačinskas and Gintaris Kaklauskas

*Department of Bridges and Special Structures,
Vilnius Gediminas Technical University, Saulėtekio al. 11, LT-10223 Vilnius-40, Lithuania
E-mail: bridge@st.vtu.lt*

Abstract. Reinforced concrete structures subjected to fire will generally experience a complex behaviour. This paper presents a strategy of numerical simulation of reinforced concrete members exposed to high temperatures and subjected to external loading. Finite element modelling of full load-deflection behaviour of experimental reinforced concrete beams reported in the literature has been carried out. A constitutive model based on Eurocode 2 specifications has been used in the analysis. Comparison of numerical simulation and test results has shown a reasonable accuracy.

Keywords. thermo-mechanical numerical simulation, reinforced concrete, non-linear finite element analysis, thermo-mechanical tests, constitutive models of concrete and steel.

1. Introduction

There are many buildings and civil engineering works (tunnels, high-rise buildings, bridges, containment shells, airport runways etc) under construction which are at risk of fire. A few dramatic accidents in recent past have prompted investigations in the field of safety of reinforced concrete structures subjected to a fire. Fires in railway Channel Tunnel (Autumn, 1996), in the road tunnels of Mont Blanc (France/Italy 1999, Fig 1), in the Twin Towers (NY, 2001) should be mentioned [1]. In all cases, the load-bearing capacity of a structure under the actual fire conditions is of primary importance for the evacuation of persons, as well as for the safety of rescue teams.

The analysis of the behaviour of load-bearing members under high temperature conditions is very complicated [2]. Various factors that influence the behaviour of the members need to be taken into account, including: variation of member temperature with time, variation of temperature over the cross-section and along the member, temperature effects on material properties, material non-linearity, section shape etc.

Because of the non-linear nature of the problem, closed-form solutions usually cannot be found by the trivial way [3]. The non-linear behaviour of a member under elevated temperature conditions can be simulated using the numerical methods [4, 5].

This paper presents a strategy of numerical simulation of reinforced concrete (RC) members exposed to high temperatures and subjected to mechanical loading. Full load-deflection behaviour of experimental reinforced concrete beams was modelled by the finite element software MSC.Marc [6]. A constitutive model based on Eurocode 2 specifications for fire design [7] has been used in the analysis. Comparison of numerical simulation and test results has been carried out.



Fig 1. A vehicle after fire in the tunnel

2. Fire tests of typical RC beams

The present analysis employs experimental data [8] of RC beams subjected to external loading at elevated temperatures. Specimens were heated on three surfaces (the bottom and two lateral surfaces). They were tested in the temperature-force path: first heated up to a fixed temperature, and then loaded to failure. As the loading time was very short compared to its heating time, the thermal duration effect during loading can be neglected. The paper includes modelling results of three beams, first exposed to temperatures of 20 °C, 400 °C and 600 °C, respectively, and then subjected to external loading.

The loading configuration and specimen dimensions are shown in Fig 2. The mean compressive cube strength of concrete is 29,45 MPa. The low-carbon plain steel bars with diameter 10 mm and yield stress 270 MPa at room temperature were used as tensile and compressive reinforcement, while those with diameter 4 mm and yield stress 289 MPa at room temperature were used as stirrups. The specimen tensile steel ratio was 0,95 % and the stirrup spacing was 80 mm.

The temperature distribution was measured along the cross-section depth at 20 mm from the lateral surface and across the section width at 75 mm from specimen soffit.

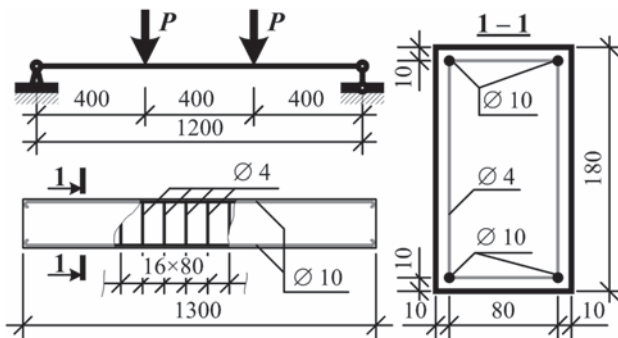

Fig 2. The loading configurations and specimen dimensions

3. Thermo-mechanical properties of materials

The reliability of a fire analysis results is strongly affected by the choice of the constitutive laws of materials and the values of their thermo-mechanical parameters. In the present numerical model, the material properties are considered to be temperature-dependent. This section describes constitutive models for concrete and steel assumed in the finite element analysis. The constitutive relationships are based on Eurocode 2 specifications [7] and recommendations [9].

3.1. Thermal properties used in the analysis

The classical equation of heat transfer is as follows:

$$\nabla^T (\kappa [\nabla \theta]) = \theta'_t; \quad \kappa = \lambda / (\rho c_v). \quad (1)$$

where θ is the space-dependent temperature and κ is the temperature-dependent thermal diffusivity. It should be noted that the thermal diffusivity is related to the density ρ , the thermal conductivity λ and the specific heat c_v . In the present analysis, density for concrete as well as for steel was taken as a constant value.

Concrete. Thermal properties of concrete are dependent on the mix proportions, the type of aggregate, the moisture content and age of concrete.

The specific heat was calculated by the equation [9]:

$$c_v(\theta) = 900 + 80 \left(\frac{\theta}{120} \right) - 4 \left(\frac{\theta}{120} \right)^2 \left[\frac{\text{J}}{\text{kg}^\circ\text{C}} \right], \quad (2)$$

and the thermal conductivity [7] was taken as

$$\lambda_c(\theta) = 2 - 24 \left(\frac{\theta}{1200} \right) + 12 \left(\frac{\theta}{1200} \right)^2 \left[\frac{\text{W}}{\text{m}^\circ\text{C}} \right]. \quad (3)$$

Steel. The values of the properties concerned are sensibly independent on the strength or grade of the steel. The specific heat and the thermal conductivity as functions of temperature [6] are shown in Fig 3.

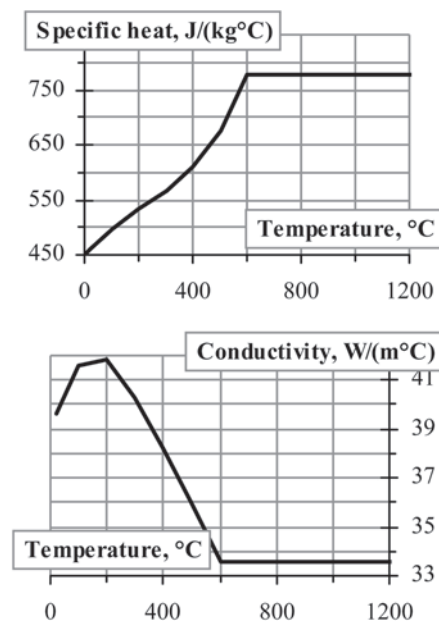

Fig 3. The specific heat and the thermal conductivity of reinforcement steel

3.2. Mechanical properties used in the analysis

To determine the structural response in a fire, it is necessary to be able to formulate constitutive laws for the mechanical behaviour of the relevant materials at elevated temperatures. A complete formulation is required only where a full analysis is undertaken to calculate deformations and displacements. Where it is only necessary to calculate load capacity, a more limited data set can be utilised. Indeed, much early work on evaluating material behaviour was di-

rected to determining specific properties such as tensile strength of steel or compressive strength of concrete at elevated temperatures. It was only much later that the need for numerical models was appreciated.

Concrete. The material model describes the behaviour of heated and loaded concrete in mathematical terms. It is based on the stress-strain relationships of heated concrete. The strain components can be modelled using the superposition theory whereby the total strain is considered to be the sum of various strain components:

$$\epsilon_{tot} = \epsilon_{\sigma}(\sigma', \sigma, \theta) + \epsilon_{th}(\theta) + \epsilon_{cr}(\sigma, \theta, t) + \epsilon_{tr}(\sigma, \theta), \quad (4)$$

where ϵ_{tot} – the total strain, ϵ_{σ} – the stress-related strain, ϵ_{th} – the thermal strain, ϵ_{cr} – the creep strain, ϵ_{tr} – the transient strain, θ – the temperature, t – the time, σ – a stress, and σ' – the stress history. The superposition theory has been particularly useful in the analysis of the strain components at a high temperature and has been found to be applicable experimentally [2]. Each of the terms of (4) is described below.

The model of the stress-strain relationships is given in Fig 4. On the compression side, the curve consists of a parabolic branch followed by a descending curve until crushing occurs. On the tension side, the curve consists of a bilinear diagram. An initial stiffness of concrete in tension is equal to that in compression. At tensile strains greater than ϵ_{cr} the concrete is assumed to follow the descending branch of the stress-strain curve. Once the concrete has crushed, it is assumed to have no residual strength in either compression or tension.

The free thermal expansion is predominantly affected by the aggregate type. Transient stress is the hindered part of thermal expansion for loaded concrete structures exposed to heating. It is an irreversible process and occurs only during the first heating. In the present analysis the free thermal strain was given by the equation [9]:

$$\epsilon_{th,c} = \begin{cases} 23 \times 10^{-12} \theta^3 + 9 \times 10^{-6} \theta - 18 \times 10^{-5}, & 20^{\circ} \text{C} \leq \theta \leq 700^{\circ} \text{C}; \\ 14 \times 10^{-3}, & \theta > 700^{\circ} \text{C}. \end{cases} \quad (5)$$

The reduction of concrete compressive strength and Young's modulus at elevated temperatures [7] is shown in Fig 5. Full stress-strain-temperature relationships are constructed on a basis of the curves (Fig 4).

Steel. The constitutive model describes the behaviour of heated and loaded steel in mathematical terms. Since transient strain does not exist for steel, the model is simpler than for concrete and is described as the sum of three terms [9]:

$$\epsilon_{tot} = \epsilon_{\sigma}(\sigma, \theta) + \epsilon_{th}(\theta) + \epsilon_{cr}(\sigma, \theta, t), \quad (6)$$

where ϵ_{tot} – total strain, ϵ_{σ} – the stress related strain, ϵ_{th} – the thermal strain, ϵ_{cr} – the thermal creep strain.

The free thermal expansion of steel is relatively independent of the steel type [9]. The value was taken by the following formula:

$$\epsilon_{th,s} = 4 \times 10^{-9} \theta^2 + 12 \times 10^{-6} \theta - 3 \times 10^{-4}. \quad (7)$$

As shown in Fig 6, the behaviour of reinforcement in

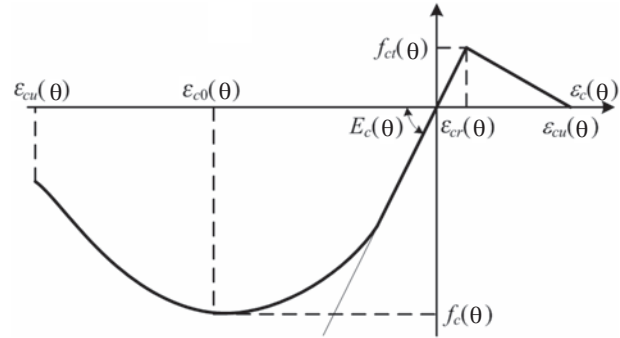

Fig 4. Model of stress-strain relationship of concrete

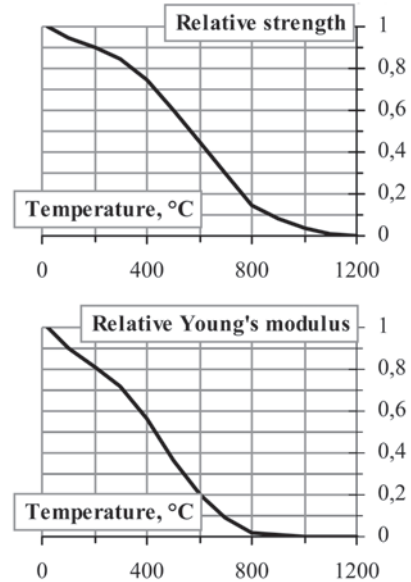

Fig 5. Reduction coefficients allowing for decrease of concrete compressive strength and Young's modulus at elevated temperatures

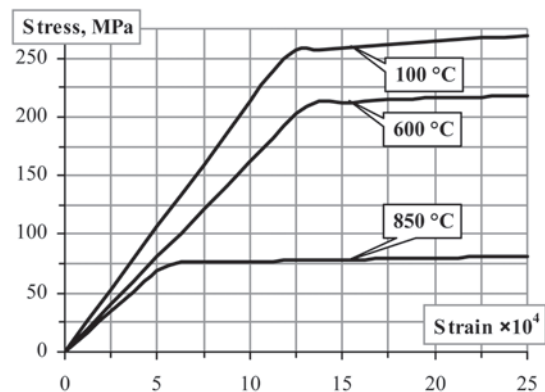

Fig 6. Idealization of stress-strain behaviour for steel at elevated temperatures

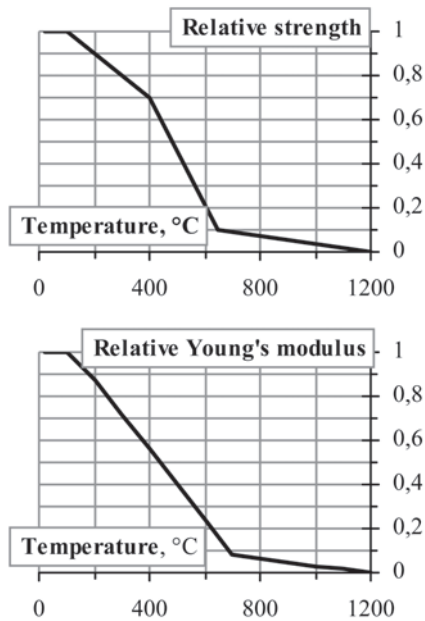

Fig 7. Reduction of strength and Young's modulus of steel at elevated temperatures

the numerical analysis is taken as elastic up to yielding. Variations of the strength and Young's modulus with respect to temperature used in the present analysis are shown in Fig 7 [7].

4. Numerical modelling of experimental beams

Numerical modelling of full load-deflection behaviour of experimental reinforced concrete beams has been carried out by the finite element (FE) software MSC.Marc [6]. Since 1971, Marc has been known for its versatility in helping market leaders in various industries to design better products and solve simple to complex real-world engineering problems. Today MSC.Marc is an advanced finite element system focused on non-linear design and analysis. MSC.Marc is known for great depth in solution procedures and material models.

4.1. Finite Element (FE) Model

FE model of beams was considered in the three-dimensional stress state with non-linear constitutive laws for concrete and reinforcement which were described above. The finite element model used for the beams is shown in Fig 8. Due to symmetry conditions, only half of the beam was modelled. Isoparametric hexagonal FE with eight integration points was used for modelling.

4.2. Numerical Analysis

The complex thermo-mechanical FE 3 D, non-linear analysis has been carried out. MSC.Marc handles the coupled thermo-mechanical analysis using a staggered solution procedure. Using this approach, the thermal problem

is solved to obtain the nodal temperatures. Next, the mechanical problem is solved for the nodal displacements.

The experimental specimens [8] were heated on three surfaces by the electric furnace, ie the bottom and two lateral surfaces. Fig 9 shows the temperature fields calculated by software package MSC.Marc at temperatures 400 and 600 °C.

As mentioned above, the temperature distribution was measured along the cross-section depth at 20 mm from the lateral surface and across section width at 75 mm from experimental specimen soffit. The comparative temperature distributions along cross-section diagrams are presented in Fig 10. Good agreement was achieved between the calculation results and the experimental data.

The calculated load-deflection diagrams are presented in Fig 11 along with the experimental curves. The modelling has included two stages: temperature exposure was followed by mechanical loading. The load-deflection diagrams correspond to three stages of structural behaviour. In the first stage corresponding to zero mechanical loading, the beam deflects downwards due to temperature differences in the bottom and top parts of the section (Fig 9). In the second, the pre-yielding stage, the deflections increase with the increasing load. In the third, the failure stage, corresponding to the yielding of reinforcement, large de-

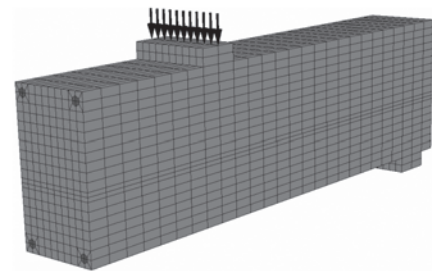

Fig 8. The finite element model used in numerical analysis by software MSC.Marc

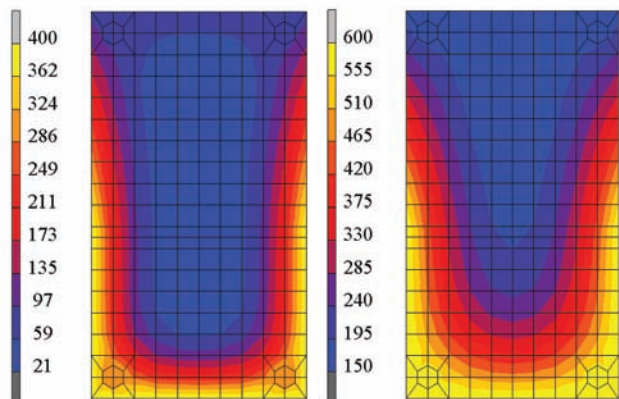

Fig 9. Calculated temperature distribution in a cross-section of the beams exposed to temperatures 400 °C (left) and 600 °C (right) achieved after 4,5 and 20 min heating, respectively

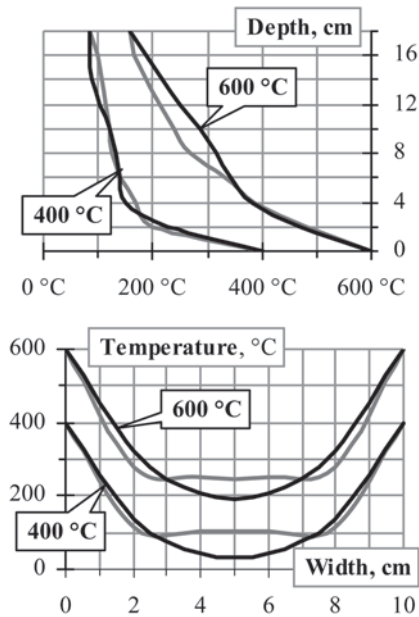

Fig 10. Experimental (grey curve) and calculated (black curve) temperature distribution along (above) and across section (below) of the beams exposed to 400 °C and 600 °C

flections were caused by small load increments. As shown in Fig 11, the calculated deflections were in good agreement with the test results. The shape of experimental load-deflection diagrams has been both qualitatively and quantitatively captured in the FE analysis.

5. Conclusions

This paper presents a strategy of numerical simulation of reinforced concrete members exposed to high temperatures and subjected to mechanical loading. Generally the numerical modelling the behaviour of such members is very complicated. Various factors that influence the behaviour of the members (such as variation of member temperature with time, variation of temperature over the cross section and along the member, temperature effects on material properties, material non-linearity, section shape etc) need to be taken into account.

In the present numerical analysis the load-deflection behaviour of reinforced concrete beams subjected to high temperatures (up to 600 °C) has been modelled by the finite element package MSC.Marc. A constitutive model based on specifications of Eurocode 2 has been used in the analysis. Comparison of the experimental and modelling results has shown that MSC.Marc has satisfactorily captured the load-deflection behaviour of the beams and it can be used for modelling the bearing reinforced concrete tunnel members.

6. Acknowledgments

The financial support under Framework 5 project “Cost-effective, Sustainable and Innovative Upgrading

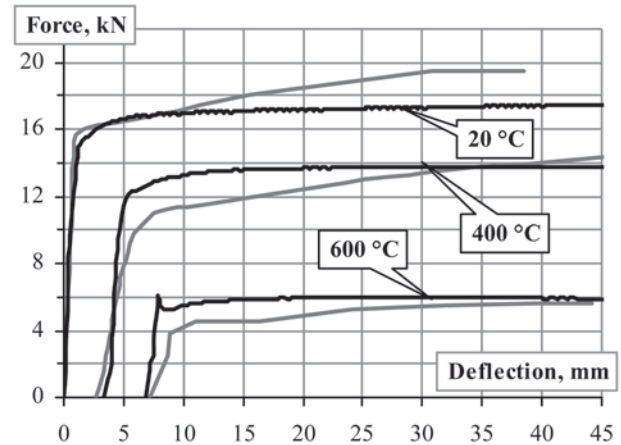

Fig 11. Experimental (grey curve) and calculated (black curve) load-deflection diagrams

Methods for Fire Safety in Existing Tunnels” (UPTUN, project No GRD1-2001-40739/UPTUN) provided by the European Community is gratefully acknowledged.

The financial support provided by the Lithuanian State Science and Studies Foundation is gratefully acknowledged.

References

1. FELICETTI, R.; GAMBAROVA, P. G. Meda A. Expertise and Assessment of Structures after Fire. In: Report in the Meeting of fib Task Group 4.3.2 Guidelines for the Structural Design of Concrete Buildings Exposed to Fire. Brussels: CEN TC, 2002, p. 89–99.
2. KAKLAUSKAS, G.; GHABOUSSI, J. Stress-Strain Relations for Cracked Tensile Concrete from RC Beam Tests. *ASCE Journal of Structural Engineering*, Vol 127, Issue 1, p. 64–73.
3. BAŽANT, Z. P.; KAPLAN, M. F. Concrete at High Temperatures: Material Properties and Mathematical Models. New York: Longman Group Lt., 1996. 424 p.
4. KAKLAUSKAS, G. Flexural Layered Deformational model of Reinforced Concrete Members. *Magazine of Concrete Research*, Vol 56, No 10, p. 575–584.
5. BAČINSKAS, D.; KAKLAUSKAS, G.; GEDA, E. FE Software ATENA Applications to Non-Linear Analysis of RC Beams Subjected to High Temperatures. *Journal of Civil Engineering and Management*, Vol X, Suppl 1, p. 11–18.
6. MSC.Marc. Vol. A: Theory and User Information, Version 2003. Redwood City, California: MSC.Software Corp., 2003. 748 p.
7. prENV 1991-1-2. Eurocode 2: Design of Concrete Structures - Part 1.2: General Rules – Structural Fire Design. Brussels: CEN, 2001. 102 p.
8. SHI, X.; TAN, T.-H.; TAN, K.-H.; GUO, Z. Effect of Force-Temperature Paths on Behaviours of Reinforced Concrete Flexural Members. *Journal of Structural Engineering*, Vol 128, No 3, p. 365–373.
9. PURKISS, J. A. Fire Safety Engineering Design of Structures. Oxford: Butterworth Heinemann, 1996. 342 p.