

Article citation info:

Ružinskas A, Giessler M, Gauterin F, Wiese K, Bogdevičius M. Experimental investigation of tire performance on slush. *Eksploatacja i Niezawodność – Maintenance and Reliability* 2021; 23 (1): 103–109, <http://dx.doi.org/10.17531/ein.2021.1.11>.

Experimental investigation of tire performance on slush

Andrius Ružinskas^{a*}, Martin Giessler^b, Frank Gauterin^b, Klaus Wiese^c, Marijonas Bogdevičius^a

Indexed by:



Department of Mobile Machinery and Railway Transport, Vilnius Gediminas Technical University, Plytinės str., 27 10105 Vilnius, Lithuania

Institute of Vehicle System Technology, Karlsruhe Institute of Technology, Kaiserstrasse., 2 76131 Karlsruhe, Germany

Continental Reifen Deutschland GmbH, Jädekamp., 30 30419 Hannover, Germany

Highlights

- This paper presents the experimental investigation of tire performance on slush.
- Slush is defined as a mixture of snow and water, and a mixture of crushed ice and water.
- Tire friction decreases increasing the mixture amount of snow and water.
- Tire friction increases increasing the mixture amount of crushed ice and water.
- The results of performed tire tests showed a good reproducibility and reliability.

Abstract

An investigation of tires behaviour on winter roads was always a high importance in the context of road safety. This paper presents the experimental investigation of tire performance on slush that is identified as two mixtures: a mixture of snow and water, and a mixture of crushed ice and water. The measurements of longitudinal and lateral performance including tire traction, braking and cornering were performed. Tire traction tests were performed for both mixtures with different amount of material. A decreasing in the tire friction was observed when amount of the mixture of snow and water was increased twice. For the mixture of crushed ice and water, an opposite trend was observed. The standard deviation values for the peak force coefficient showed a good reproducibility and reliability of performed tire tests.

Keywords

This is an open access article under the CC BY license (<https://creativecommons.org/licenses/by/4.0/>)

slush, tire, friction, longitudinal force, lateral force, force coefficient.

1. Introduction

The frictional behaviour of tires on any surface is important for vehicle safety and control [14, 24]. As tires are in direct contact with the pavement, the vehicle is controlled directly due to its tire friction with the pavement, and parameters of the tires have a great influence on controlling stability and ride safety of the vehicle [21]. The tire is the only component transmitting forces between the vehicle and the ground, thus it has to maintain high forces during all driving maneuvers [15]. Also, a knowledge of the current tire-road friction is essential for future autonomous vehicles [2]. In general, the tire performance is evaluated within longitudinal and lateral slip curves. The shape of the curve is influenced by many parameters, for example the friction characteristics of the tread rubber, which itself is influenced by the texture of the road surface, the medium between the road and the tire (e.g. water, snow, ice etc.) and the tire tread compounds [19].

In research papers a number of experimental studies of tire performance on snow and ice can be found. The effects of operational parameters, namely load on the tire, inflation pressure, toe angle, tread depth, camber angle, ice temperature, ambient temperature and type of ice surface using Standard Reference Test Tire were studied with indoor test method [3] and outdoor test method [4]. Cutini et al. [8] presented a method for testing winter tires in outdoor test facilities on compacted snow and on iced surface. Results showed that the method

was able to measure the small differences between the traction force of the different sets of tires. Hjort et al. [12] presented a comprehensive study of the performance of winter tires on snow, ice, and asphalt using a mobile tire-testing device for snow and asphalt, and using stationary tire-testing facility for ice. Both devices recorded the tire forces and motions, and results suggested that the recorded data represent real vehicle performance. Salimi et al. [20] investigated the friction behaviour of tire with ice and snow using RT3-Curve, a lateral friction measuring device. The study showed that ice had 55 % less friction compared to bare dry conditions. Light, moderate, and heavy snow reduced the dry surface friction significantly by 69, 75, and 81 %, respectively. Yokoyama et al. [23] studied the friction performance of tires on snow covered roads to predict vehicle performance within the grip range. The findings indicated that tire frictional force, as an aspect of vehicle dynamic performance on snow covered roads, can predict subjective evaluation results from actual vehicles by means of tire pattern, compound, and contact patch pressure distribution characteristics.

Unlike the tire performance on snow and ice, only a couple approaches can be found of investigation on tire performance on slush. According to Klein-Paste [17] slush mainly consists of water and ice particles and behaves like an incompressible fluid. The tire braking action on slush is mainly reduced because of hydroplaning. When a

(*) Corresponding author.

E-mail addresses: A. Ružinskas - andrius.ruzinskas@vilniustech.lt, M. Giessler - martin.giessler@kit.edu, F. Gauterin - frank.gauterin@kit.edu, K. Wiese - klaus.wiese@conti.de, M. Bogdevičius - marijonas.bogdevicius@vilniustech.lt

tire rolls on a pavement covered with an incompressible fluid, it is squeezing the fluid from under the footprint. This squeezing process generates pressures on the surface of the tire footprint, delaying or preventing it to get into contact with the underlying pavement. When full hydroplaning occurs it provides almost no braking action as the tire slides over the fluid film without reaching the pavement texture at all. Hydroplaning is largely speed dependent since the speed determines how much time is available for the squeeze out. However, it is also largely dependent on the fluid thickness.

Lee and Huang [13] used a physical tire-snow interaction model and presented results of calibration and validation of the interaction model for wet snow wherein the volume fraction of water content ranges from 3 % to 8 %. The main differences between dry and wet snow were noticed in a higher coefficient of friction for the rear wheel on dry snow than wet, and the traction force for wet snow was higher than for dry indicating lower motion resistance for wet snow. In Bhoopalam et al [5] study a slush with soil definition was used evaluating the tire traction performance on different icy roads. The study showed a 300 % increase in the peak traction during operation on ice covered with soil and slush (shaved ice and water mix), compared to wet ice (ice covered with a thin layer of liquid water). Bogdevičius et al [6] presented a theoretical approach of mechanism of force transmission between a tire and slush-covered pavement. The mathematical approach analysed the system “sub-block-slush layer-drum”, wherein the slush was described as a multi-layer bulk. The model evaluated mass change velocity of slush layer and physical-mechanical properties of sub-block. The obtained velocities of slush layers and friction forces enabled to determine generated heat per time unit at each layer. Results showed that the top layer of slush has the highest velocity and heat flow values.

This paper presents a comprehensive experimental study on tire performance on slush that is identified with two different mixtures. The experimental setup including test equipment, track preparation, test procedure and the tire friction values for longitudinal and lateral tire performance including tire traction, braking and cornering are presented and discussed.

2. Experimental setup

In the following chapter experimental setup including test equipment, track preparation and test procedure are presented. The Internal Drum Test Bench in Karlsruhe Institute of Technology was used to perform measurements of tire force transmission on the different amount and consistency of slush layer.

2.1. Test equipment

The Internal Drum Test Bench of Karlsruhe Institute of Technology, showed in Fig. 1 allows tire measurements in controllable winter conditions such as ice or snow. The test rig consists of the internal drum (4) with a diameter of 3.8 m, wherein the tire (2), mounted on a rigid wheel suspension, rolls on the installed track (5). Wheel and drum can be driven independently for braking and traction tests. Slip and camber angles, and vertical force are adjusted by hydraulic system. The main technical specifications of the test bench are presented in [11, 22]. All tire response data is measured inside the wheel hub by a six-component measurement hub (3) and the main outputs are: longitudinal force (F_x), lateral force (F_y) and vertical (wheel reaction) force (F_z).

The test rig is surrounded by a climate chamber with an air conditioning system which allows cool down the testing room to -20°C . For measurements on ice and snow tracks the test rig can be additionally equipped with a snow production machine, a roller for snow compaction, a blade (7) for cutting ice or snow layer and infrared camera for temperature measurements.

A special winter tire 205/55 R16 was used for the measurements. The tire footprint at about 4000 N vertical load and 220 kPa inflation pressure is showed in Fig. 2.

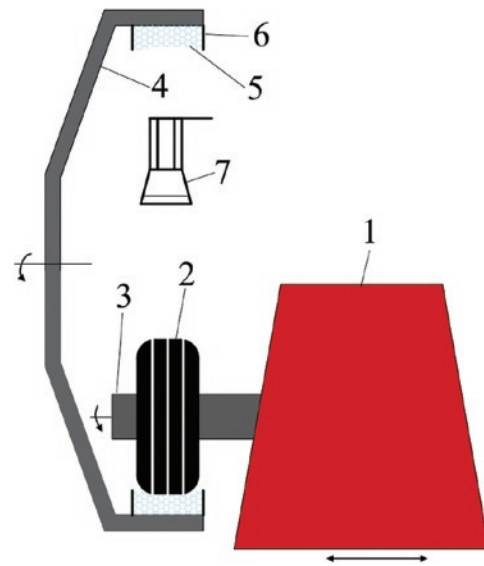

Fig. 1. Schematic view of the test bench. 1 – test stand; 2 – tested tire; 3 – measuring hub; 4 – internal drum; 5 – track; 6 – borders; 7 – hydraulic blade.

As it is seen from Fig. 2, the tire has a non-symmetrical tread pattern. Its depth was 8 mm and shore hardness was 56A. The tire was always kept in the testing room before the each measurement.



Fig. 2. The footprint of the tested tire

2.2. Slush track preparation

According to [10] slush is a mixture of water and snow, at the temperature of zero or a little above the freezing point. Slush behaves as a liquid in the sense that only insignificant shear forces may be transmitted. The density of slush depends on its water content and is always less than the density of water. The viscosity of slush is always larger than that of water, and always increases with decreasing water content. In The International Classification for Seasonal Snow on the Ground [9] and [18] slush is presented as a soaked snow which has a small air content and liquid water content is greater than 15 %. The temperature of snow is equal or higher than 0°C .

The main challenge preparing the slushy track was to keep the mixture on the drum as much as possible to get a good track reproducibility when tire is rolling. For this reason, the special borders (6), showed in Fig. 1, were installed not allowing to splash away the mixture from the drum when tire was rolling. The next challenge was to equalize

the slush mixture on the drum and don't let it to fall down when drum is rotating. After some attempts, it was decided to throw mixed material directly on the rotating drum expecting that centrifugal forces F_c showed in Fig. 3 will make it stick on the drum surface and prevents from sliding. For this reason, a required drum speed was calculated for different angle situations.

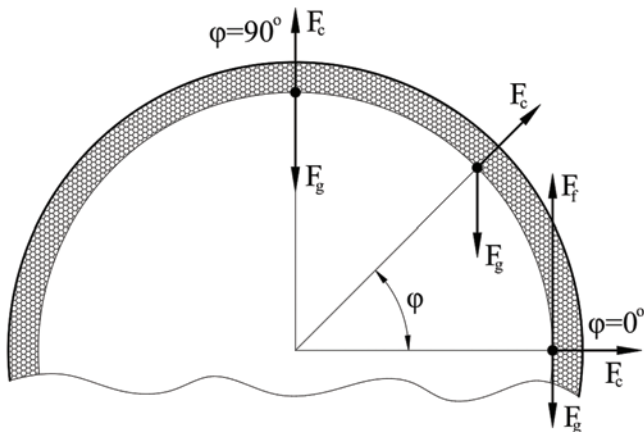

Fig. 3. Forces acting on the slush at different angle when drum is rotating

When slush mixture is at 90° angle, the centrifugal F_c and gravity F_g forces are equalized:

$$mg = \frac{mV_D^2}{R} \quad (1)$$

where V_D refers to drum speed and R refers to drum radius. Then drum speed can be expressed:

$$V_D = \sqrt{gR} \quad (2)$$

A force equilibrium can be expressed accordingly to the angle $0^\circ < \varphi < 90^\circ$ and drum speed is calculated:

$$mg = \frac{mV_D^2}{R} \sin \varphi \quad (3)$$

$$V_D = \sqrt{\frac{gR}{\sin \varphi}} \quad (4)$$

At 0° a cohesion force occurs, thus equalizing total friction force F_f with gravity force F_g , we obtain:

$$\frac{mV_D^2}{R} \mu + F_c = mg \quad (5)$$

Then from equation (5) friction coefficient μ and drum speed V_D are expressed:

$$\mu = \frac{R}{mV_D^2} (mg - F_c) \quad (6)$$

$$V_D = \sqrt{\frac{R}{\mu m} (mg - F_c)} \quad (7)$$

Assuming that cohesion force F_c which should increase the friction between the mixture and the drum surface is neglected, the minimum required speed of the drum is about 55 km/h (or about 277 rpm). The calculated friction value was 0.07 wherein F_c was also neglected.

It was calculated that for 2 cm of height 62 l of mixture are required. According to the calculation, the ratios of the mixture were selected.

In this study slush was identified as a mixture of snow and water, and a mixture of crushed ice and water. According to the slush definition presented in [9], the mixture should have more than 15 % of water. Therefore, for the mixture of snow and water the ratios of 5.5:1 (55 l of snow and 10 l of water) and 11:2.2 were selected. For the mixture of crushed ice and water the ratios of 6:0.75 (60 l of crushed ice and 7.5 l of water) and 11:1.5 were selected.

For the mixture of snow and water, a snow was produced by cutting ice with the blade (7) showed in Fig. 1. The ice was formed on the drum by pouring the water at the temperature below 0°C . Usually, for the tire-snow measurements snow is produced by snow production machine that is using a liquid nitrogen. In our case, the presented snow production method appeared to be more cost effective and allowed to get a loose snow of about 400 kg/m^3 density. Further snow is mixed up with the water and density of the mixture is determined. An average density value for the snow and water mixture was 815 kg/m^3 with the standard deviation of 56 kg/m^3 . Then prepared mixture (Fig. 4a) is thrown on the rotating drum at already calculated speed (55 km/h). After stopping the drum (Fig. 4c), an initial height of the mixture is measured that is about 2 cm or 4 cm according to the ratio of the mixture.

The mixture of crushed ice and water (Fig. 4b) is prepared accordingly to the mixture of snow and water. Simple ice cubes that are crushed into small pieces (ice particles) and mixed up with the water were used. An average density of the mixture was about 674 kg/m^3 with the standard deviation of 39 kg/m^3 . The prepared mixture is thrown on the rotating drum and the same initial height of 2 cm and 4 cm was obtained according to the ratio of the mixture.

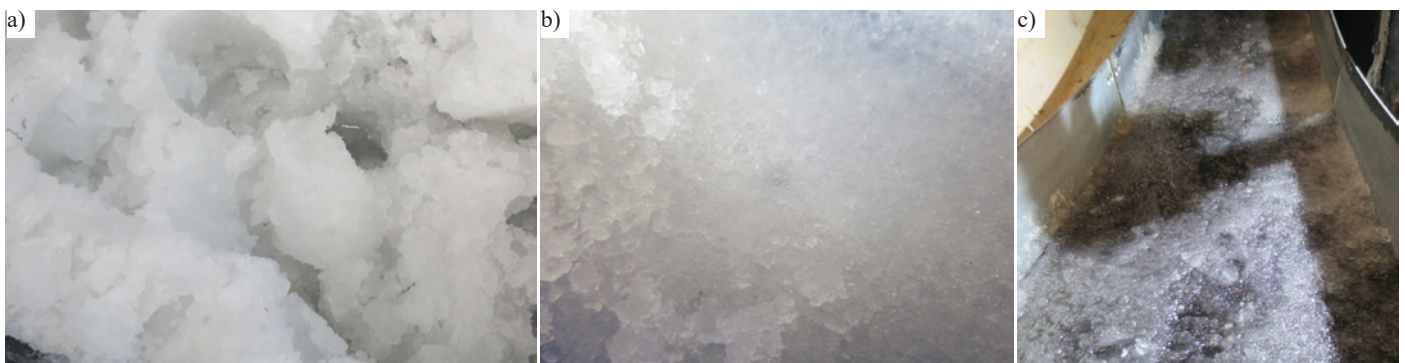

Fig. 4. Slush production. a) – mixture of snow and water. b) – mixture of crushed ice and water. c) – mixture of snow and water on the drum

2.3. Test procedure

Once the track is prepared, the tire is installed on the test bench and measurements could be performed recording the force and moment data. The longitudinal tire slip S_x is calculated by:

$$S_x = \frac{\Omega R_{dyn} - V_D}{V_D} \quad (8)$$

where Ω refers to the angular velocity of the tire, R_{dyn} refers to dynamic rolling radius of the tire that is determined while the wheel is freely rotating before the measurement starts. Positive values represent traction and negative values braking slip.

The values of test parameters are presented in Table 1. For every test the ambient temperature in the cooling chamber was kept about 0-1°C. The tire was rolling on the drum loaded with 4000 N, inflated with the pressure of 220 kPa and with 0° camber angle. The driving speed (the drum speed) was selected about 50 km/h constant speed. Then the tire is accelerated or decelerated with in the test bench. The cornering tests were performed as pure cornering, i.e. with a very low slip. Up to 80 % slip is reached when tire is accelerated and about 70 % slip when it is braked. The tire turning (slip) angle has ranged from -4° to 4° and was limited because of installed borders on the drum.

Table 1. The values of test parameters

Test parameter	Value
Ambient temperature, °C	0-1
Vertical load, N	4000
Tire inflation pressure, kPa	220
Tire camber angle, °	0
Driving speed, km/h	50
Slip ratio, %	-70 - 80
Slip angle,	-4 - 4

Three types of measurements were performed: traction, braking and cornering. Traction tests were performed for both mixtures with different ratios, and for braking and cornering only with the mixture of snow and water with the ratio of 5.5:1. For every test condition at least three measurements were performed wherein after two measurements the track was renewed with the hydraulic blade showed in Fig. 1 equalizing the layer of the mixture and then one more measurement was performed. For the next test the track was renewed with the completely new mixture. The one traction or braking measurement lasted up to 15 s and cornering measurement lasted up to 35 s since a special test protocol was used specially designed for the snow track.

The results are presented as slip curves wherein a longitudinal force coefficient (the ratio of longitudinal F_x and vertical F_z forces) is the function of slip, and a lateral force coefficient (the ratio of lateral F_y and vertical F_z forces) is the function of slip angle. For longitudinal slip curves, a Magic Formula (MF) [16] was used to fit the data using a least square minimization [1]. The standard deviation was calculated for the peak values of force coefficient. For the longitudinal tire performance, the peak values were obtained from slip curves fitted with MF.

3. Results

The average slip curves for tire traction tests for different mixtures and ratios are presented in Fig. 5 and Fig. 6. Also the views of the track after the measurements are presented to get a better insight of tire performance.

A peak value of force coefficient for the mixture of snow and water with the ratio 5.5:1 is 0.3 and is reached at about 20 % slip. Increasing the amount of mixture twice decreases the force coefficient and the peak value is 0.27 that is reached at the same slip. The standard deviation for both peak values was 0.031 and 0.026 respectively, and each value was calculated from three measurements.

A peak value of force coefficient for the mixture of crushed ice and water with the ratio 6:0.75 is 0.25 and is reached at about 15 % slip. Increasing the amount of mixture twice an opposite trend was observed. The force coefficient is increasing and the peak value is 0.31 reached at about 10 % slip. The standard deviation for both peak values was 0.016 and 0.031 respectively, and was calculated from three

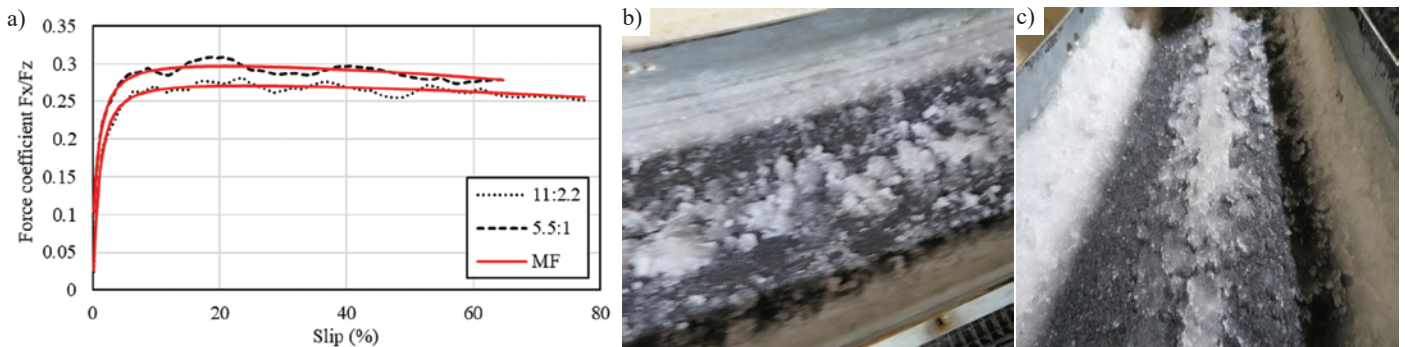

Fig. 5. Results of traction test for the mixture of snow and water a) Averaged slip curves fitted with Magic Formula for different mixture ratio b) Track after measurements for the mixture ratio 5.5:1. c) Track after measurements for the mixture ratio 11:2.2.

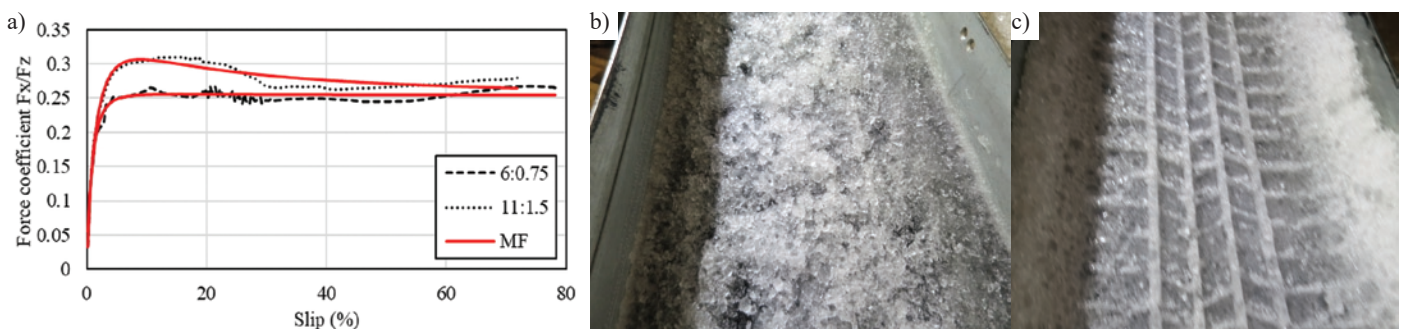

Fig. 6. Results of traction tests for the mixture of crushed ice and water. a) Averaged slip curves fitted with Magic Formula for different mixture ratio. b) Track after measurements for the mixture ratio 6:0.75. c) Track after measurements for the mixture ratio 11:1.5.

measurements for the mixture ratio 6:0.75, and from four measurements for the mixture ratio 11:1.5.

An average slip curve with Magic Formula for the tire braking test is presented in Fig. 7.

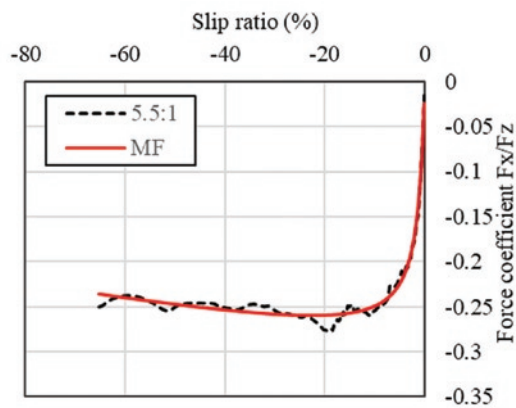

Fig. 7. Averaged braking slip curve fitted with Magic Formula for the mixture of snow and water with the ratio 5.5:1.

A peak value of the braking force coefficient for the mixture of snow and water is equal to 0.26 and is reached at about 20 % slip, the same value as for traction test. The peak value of braking is lower than the peak value of traction (0.30) with the same mixture ratio. The standard deviation of 0.02 for the peak value was calculated from three measurements.

An average slip curve for the tire cornering test is presented in Fig. 8.

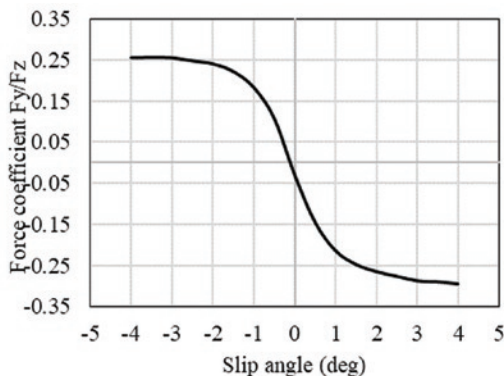

Fig. 8. Averaged cornering slip curve for the mixture of snow and water with the ratio 5.5:1.

For the cornering, the peak values of force coefficient at negative and positive angles aren't equal. At negative slip angle the peak value is 0.26 and for the positive angle the value is higher, and is equal to 0.3. Both values are reached at about 4° of slip angle. The standard deviation for both peak values is less than 0.01, that was calculated from three measurements.

4. Discussion

In this chapter the obtained results are explained and for this reason the schematic view of the tire interaction with slush mixture is presented in Fig. 9.

In experimental studies, when a tire interacts with the mixture of snow and water, three zones appear in the contact area wherein different forces act on the tire surface (Fig 9a).

In the first zone, the tire surface is subjected to a high hydrodynamic pressure. The magnitude of the pressure depends on the thickness and rate of change of the slush layer, slush density and tire speed in the horizontal and vertical directions.

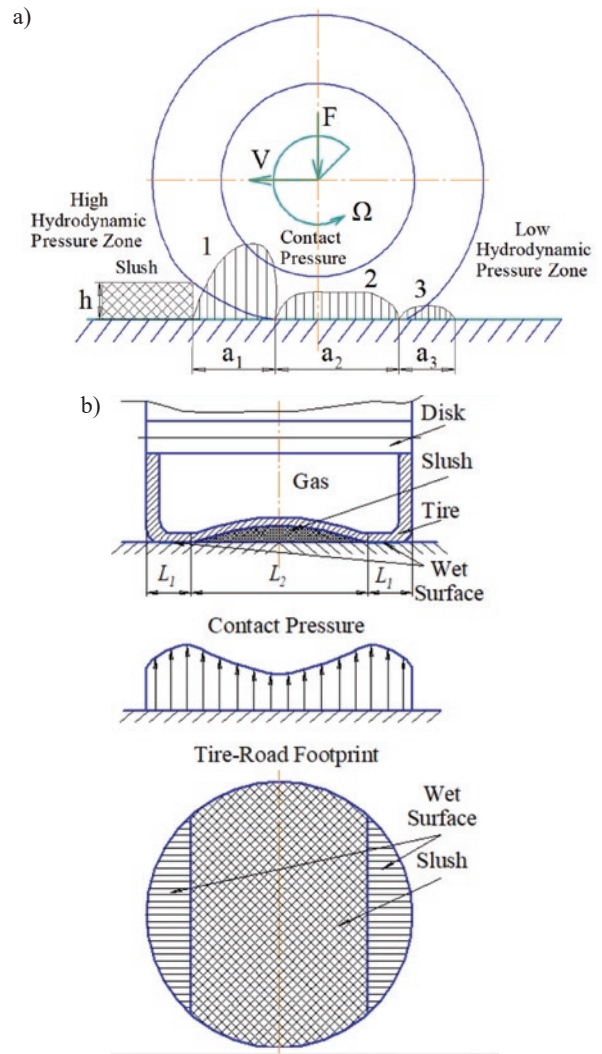

Fig. 9. Schematic view of the tire interacting with slush mixture. (a) Contact zones. (b) Pressure distribution between tire and surface

The viscosity of slush (fluidized snow) is about 50 times higher than that of water ($94.10 / 1.7914 = 52.53 \text{ Pa}\cdot\text{s}$). The viscosity of slush depends on the amount of snow and water. The higher the amount of water, the closer the viscosity of the slush gets to the viscosity of the water. Therefore, when the tire interacts with slush, the hydrodynamic pressure is higher than the tire interacting with water.

In the second zone, the tire has contact with the road surface (the drum) and slush layer. Due to the lower radial stiffness of the tire, the tire deforms more at the centre of contact, resulting in lower slush pressure at the centre of contact than it is at the tire edges. When the tire presses on the slush layer, the speed of slush outflow will also change. Because the tire edges are less deformed, in this area the tire squeezes the slush out faster and mechanical contact between the tire and the drum occurs. The slush becomes closed at the tire contact centre, i.e. the slush is unable to escape from the contact area and this zone concentrates the increased amount of slush (Fig. 5b and c).

As a result, the tangential stresses (frictional forces) at the contact between the tire and the slush will be lower when the amount of water in the slush is higher. This explains the lower tire friction with higher amount of mixture in Fig. 5a.

When the tire presses on the mixture of crushed ice and water, the space between the ice particles is reduced (air is squeezed) and the mixture becomes significantly stiffer. With each revolution of the wheel, the mixture in the rotating drum is densified. The vertical force and centrifugal forces acting on the wheel cannot disturb the structure of such a mixture, and after several revolutions of the drum, the physical and mechanical properties of the layer become

close to those of the ice cover. In such a mixture, a small amount of water (7.5 l) fills the gaps between ice and snow particles, and the mixture becomes more compressible, but the applied forces cannot destroy the structure of the mixture. The wheel is rolling on the rigid surface of the mixture. Increasing the amount of water in the mixture of ratio 11:1.5 increases the space between the hard pieces of ice, making the mixture less stiff.

The forces acting on the mixture (wheel contact force and centrifugal forces) disrupt the structure of the mixture and the tire tread digs into the mixture layer. As a result, the contact area of the tire increases with the frictional forces. The higher water content in the mixture increases the tire friction. This explains the higher values of force coefficient obtained with the higher amount of mixture in Fig. 6a.

The lower friction for braking (Fig. 7) compared with the traction is explained as follows: when tire is accelerated, the pressure in the first zone (Fig. 9a.) increases and when it is braked, the tire angular velocity Ω decreases and the pressure in the first zone is lower as similar to aquaplaning [7]. The wheel reaction F_z and longitudinal F_x forces also decrease, but due to increased area of slush (Fig. 9b.) the longitudinal force F_x is decreasing at higher rate than reaction force.

The difference in lateral tire friction at positive and negative slip angles (Fig. 8) could be led by the non-symmetrical tire tread pattern (Fig. 2).

A good repeatability and reliability were observed with the peak values of force coefficient for all performed tests. The values of standard deviation ranged from 0.01 to 0.031 indicating that the peak values of force coefficient lied in a narrow band.

5. Conclusion

In this study, an experimental investigation of tire performance on slush is proposed. The experimental tests were performed with Internal Drum Test Bench wherein the tire is able to run on the pre-in-

stalled road track. The slush was identified as two mixtures: a mixture of snow and water, and a mixture of crushed ice and water. Based on slush definition presented in [9] the mixture ratios were selected. For the mixture of snow and water, it was 5.5:1, i.e. 55 l of snow and 10 l of water, and 11:2.2 accordingly. For the mixture of crushed ice and water, the ratios were as follows: 6:0.75 and 11:1.5. The required drum speed, at which should be thrown a mixture on the drum to get equally distributed layer, was calculated from the forces acting on slush in rotating drum. Tire traction tests were performed for both mixtures. A decreasing in the tire friction was observed when amount of the mixture of snow and water was increased twice. The peak value of force coefficient decreased from 0.3 to 0.27. For the mixture of crushed ice and water, an opposite trend was observed. Increasing the amount of mixture increased tire friction. The peak value of force coefficient increased from 0.25 to 0.31. The tire braking and cornering tests were performed with the mixture of snow and water with the ratio 5.5:1. It was observed that tire has lower friction for braking compared with the traction for the same ratio of mixture. For the tire cornering, a lower tire friction was observed for the negative slip angle compared with positive angle. The low standard deviation values for the peak force coefficient of all performed tests showed a good reproducibility and reliability of presented test method.

Acknowledgement

The research work has been supported by the Research Council of Lithuania Fund within the project "Investigation of tribological micro-macro processes in multi-phase layer with ice-snow particles and their contribution to tire-layer-surface system", project code P-MIP-17-233.

References

1. Alagappan V A, Rao N V K, Kumar K R. A comparison of various algorithms to extract Magic Formula tyre model coefficients for vehicle dynamics simulations. *Vehicle System Dynamics* 2015; 53(2): 154-178, <http://dx.doi.org/10.1080/00423114.2014.984727>
2. Albinsson A, Bruzelius F, Jacobson B, Fredriksson J. Design of tyre force excitation for tyre-road friction estimation. *Vehicle System Dynamics* 2017; 55(2): 208-230, <http://dx.doi.org/10.1080/00423114.2016.1251598>
3. Bhoopalam K A, Sandu C, Taheri S. Experimental investigation of pneumatic tire performance on ice: Part I – Indoor study. *Journal of Terramechanics* 2015; 60: 43-54, <http://dx.doi.org/10.1016/j.jterra.2015.02.006>
4. Bhoopalam K A, Sandu C, Taheri S. Experimental investigation of pneumatic tire performance on ice: Part II – Outdoor study. *Journal of Terramechanics* 2015; 60: 45-62, <http://dx.doi.org/10.1016/j.jterra.2015.03.001>
5. Bhoopalam K A, Sandu C, Taheri S. Tire traction of commercial vehicles on icy roads. *SAE International Journal of Commercial Vehicles* 2014; 7(2): 357-365, <http://dx.doi.org/10.4271/2014-01-2292>
6. Bogdevičius M, Ružinskas A, Vadlūga V, Bogdevičius P, Kačianauskas R, Maknickas A, Gauterin F. Investigation of tire force transmission on interaction with slush. *Problemy Transportu – Transport Problems* 2019; 14(1): 13-21, <http://dx.doi.org/10.21307/tp.2019.14.1.2>
7. Cho R J, Lee W H, Sohn S J, Kim J G, Woo S J. Numerical investigation of hydroplaning characteristics of three-dimensional patterned tire. *European Journal of Mechanics A/Solids*, 2006; 25: 914-926, <https://doi.org/10.1016/j.euromechsol.2006.02.007>
8. Cutini M, Brambilla M, Toscano P, Bisaglia C, Abbati G, Meloro G. Evaluation of drwabar performance of winter tyres for special purpose vehicles. *Journal of Terramechanics* 2020; 87: 29-36, <https://doi.org/10.1016/j.jterra.2019.10.002>
9. Fierz C, Armstrong R L, Durand Y, Etchevers P, Green E, McClung D M, Nishimura K, Satyawali P K, Sokratov S A. The International Classification for Seasonal Snow on the Ground. IHP-VII Technical Documents in Hydrology Nr. 83, 2009.
10. Fristedt K, Norrbom B. Studies of contaminated runways. The Aeronautical Research Institute of Sweden, 1980.
11. Giessler M, Gauterin F, Wiese K, Wies B. Influence of friction heat on tire traction on ice and snow. *Tire Science and Technology* 2010; 38(1): 4-23, <http://dx.doi.org/10.2346/1.3298679>
12. Hjort M, Eriksson O, Bruzelius F. Comprehensive study of the performance of winter tires on ice, snow, and asphalt roads: The influence of tire type and wear. *Tire Science and Technology* 2017; 45(3): 175-199, <https://doi.org/10.2346/tire.17.450304>
13. Lee H J, Huang D. Vehicle-wet snow interaction: testing, modeling and validation. *Journal of Terramechanics* 2016; 67: 37-51, <http://dx.doi.org/10.1016/j.jterra.2016.08.001>
14. Levulytė L, Žuraulis V, Sokolovskij E. The research of dynamic characteristics of a vehicle driving over road roughness. *Eksplatacija i Niezawodnosc – Maintenance and Reliability* 2014; 16(4): 518-525
15. Linke T, Wiese K, Wangenheim M, Wies B, Wallashek J. Investigation of snow milling mechanics to optimize winter tire traction. *Tire Science and Technology* 2017; 45(3): 162-174, <https://doi.org/10.2346/tire.17.450302>

16. Pacejka, B H. *Tire and vehicle dynamics*. Amsterdam: Elsevier, 2012.
17. Paste A K. Airplane braking friction on dry snow, wet snow or slush contaminated runways. *Cold Regions Science and Technology*, 2018; 150: 70-74, <http://dx.doi.org/10.1016/j.coldregions.2017.02.004>
18. Piskova M, Jarausch S, Kopf Ch, Novak P, Trappmann D. An introduction to the basic properties and mechanics of snow. *Snow and Avalanches*, Winter 2008; 09: 1-22.
19. Riehm P, Unrau H J, Gauterin, Torbrügge S, Wies B. 3D brush model to predict longitudinal tyre characteristics. *Vehicle System Dynamics* 2019; 57(1): 17-43, <https://doi.org/10.1080/00423114.2018.1447135>
20. Salimi S, Nassiri S, Bayat A, Halliday D. Lateral coefficient of friction for characterizing winter road conditions. *Canadian Journal of Civil Engineering* 2016; 43(1): 73-83, <http://dx.doi.org/10.1139/cjce-2015-0222>
21. Sapragonas J, Keršys A, Makaras R, Lukoševičius V, Juodvalkis D. Research of the influence of tire hydroplaning on directional stability of vehicle. *Transport* 2014; 28(4): 374-380, <http://dx.doi.org/10.3846/16484142.2013.865673>
22. Wassertheurer B, Gauterin F. Investigation of winter tire characteristics on different track surfaces using a statistical approach, *Tire Science and Technology* 2015; 43(3): 195-215, <https://doi.org/10.2346/tire.15.430304>
23. Yokoyama T, Hiratsuka K, Notoni Sh. A study of tire characteristics and vehicle performance on snow-covered roads. *SAE Technical Paper* 2015-01-1522, 2015; 1-9, <https://doi.org/10.4271/2015-01-1522>
24. Žuraulis V, Garbinčius G, Skačkauskas P, Prentkovskis, O. Experimental study of winter tyre usage according to tread depth and temperature in vehicle braking performance. *Iranian Journal of Science and Technology, Transactions of Mechanical Engineering* 2020; 44: 83-91, <https://doi.org/10.1007/s40997-018-0243-0>